

Description

The DL0521D3L is a bi-directional TVS diode, utilizing leading monolithic silicon technology to provide fast re-sponse time and low ESD clamping voltage, making this device an ideal solution for protecting voltage sensitive high-speed data lines. The DL0521D3L has an ultra-low capacitance with a typical value at 0.8pF, and complies with the IEC 61000-4-2 (ESD) with $\pm 15\text{kV}$ air and $\pm 8\text{kV}$ contact discharge. It is assembled into a SOD-323 lead-free package. The small size, ultra-low capacitance and high ESD surge protection make DL0521D3L an ideal choice to protect cell phone, digital video interfaces and other high speed ports.

Mechanical Characteristics

- ◆ Package: SOD-323
- ◆ Lead Finish: Matte Tin
- ◆ Case Material: "Green" Molding Compound.
- ◆ Moisture Sensitivity: Level 3 per J-STD-020
- ◆ Terminal Connections: See Diagram Below
- ◆ Marking Information: See Below

Dimensions and Pin Configuration

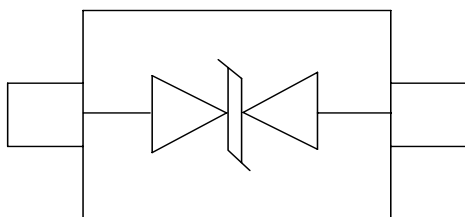

Circuit and Pin Schematic

Features

- ◆ 40W peak pulse power (8/20 μs)
- ◆ Ultra low capacitance : 0.8pF typical
- ◆ Ultra low leakage: nA level
- ◆ Low Operating: 5V
- ◆ Low clamping voltage
- ◆ Protects one power line or data line
- ◆ Complies with following standards:
 - IEC 61000-4-2 (ESD) immunity test
Air discharge: $\pm 15\text{kV}$
Contact discharge: $\pm 8\text{kV}$
 - IEC61000-4-5 (Lightning) 2A (8/20 μs)
- ◆ RoHS Compliant

Applications

- ◆ Cellular Handsets and Accessories
- ◆ Display Ports
- ◆ MDDI Ports
- ◆ USB Ports
- ◆ Digital Visual Interface (DVI)
- ◆ PCI Express and Serial SATA Ports

Marking Information



Ordering Information

Part Number	Marking	Packaging	Reel Size
DL0521D3L		3000/Tape & Reel	7 inch

Absolute Maximum Ratings ($T_A=25^{\circ}\text{C}$ unless otherwise specified)

Parameter	Symbol	Value	Unit
Peak Pulse Power (8/20 μs)	Ppk	40	W
Peak Pulse Current (8/20 μs)	I _{PP}	2	A
ESD per IEC 61000-4-2 (Air)	V _{ESD}	± 15	kV
ESD per IEC 61000-4-2 (Contact)		± 8	
Operating Temperature Range	T _J	-55 to +125	$^{\circ}\text{C}$
Storage Temperature Range	T _{stg}	-55 to +150	$^{\circ}\text{C}$

Electrical Characteristics ($T_A=25^{\circ}\text{C}$ unless otherwise specified)

Parameter	Symbol	Min	Typ	Max	Unit	Test Condition
Reverse Working Voltage	V _{RWM}			5	V	
Breakdown Voltage	V _{BR}	6		9	V	I _T = 1mA
Reverse Leakage Current	I _R			0.5	μA	V _{RWM} = 5V
Clamping Voltage	V _C			12	V	I _{PP} = 1A (8 x 20 μs pulse)
Clamping Voltage	V _C			20	V	I _{PP} = 2A (8 x 20 μs pulse)
Junction Capacitance	C _J		0.80	0.9	pF	V _R = 0V, f = 1MHz

Typical Performance Characteristics (TA=25°C unless otherwise Specified)

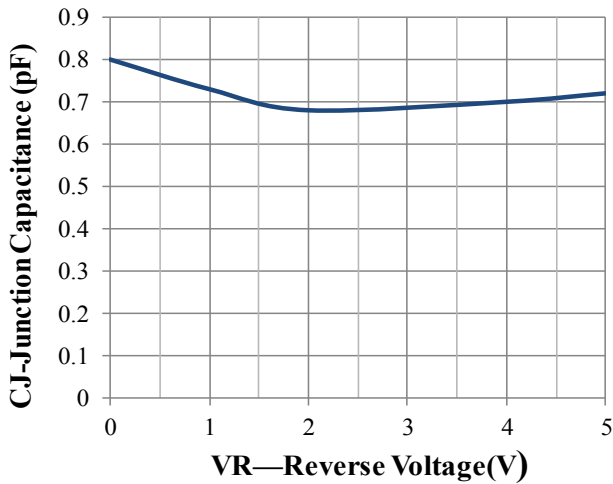

Junction Capacitance vs. Reverse Voltage

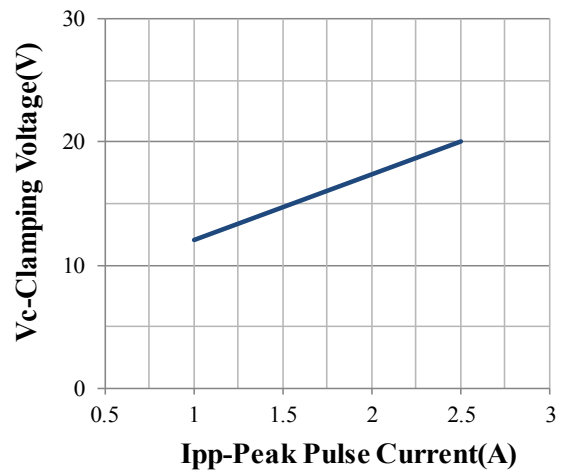

Clamping Voltage vs. Peak Pulse Current

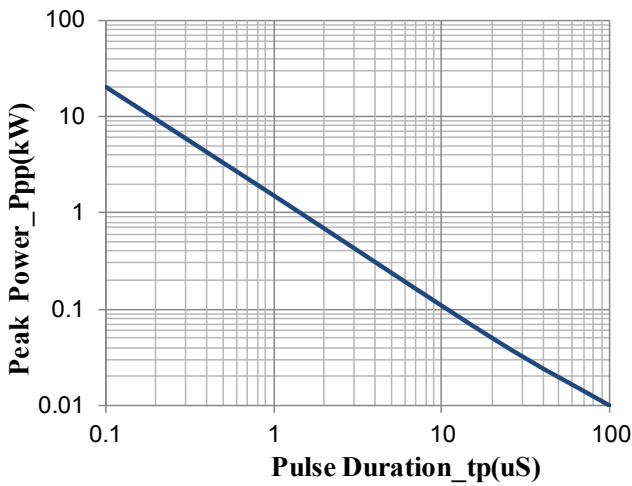

Peak Pulse Power vs. Pulse Time

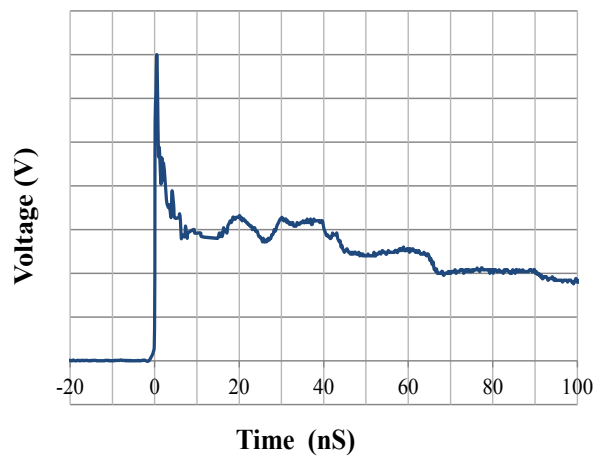

IEC61000-4-2 Pulse Waveform

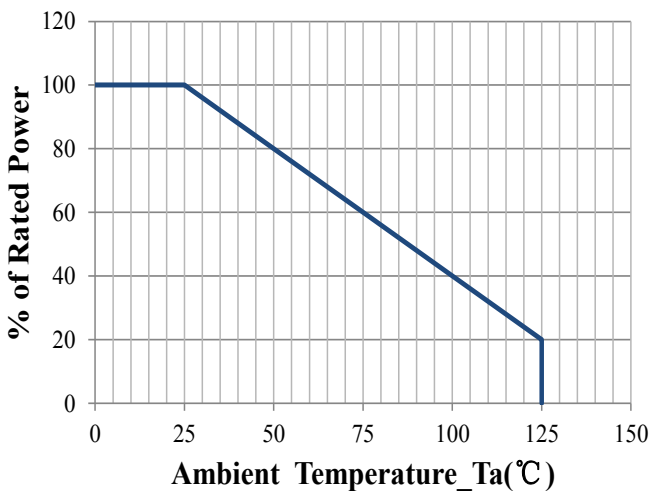

Power Derating Curve

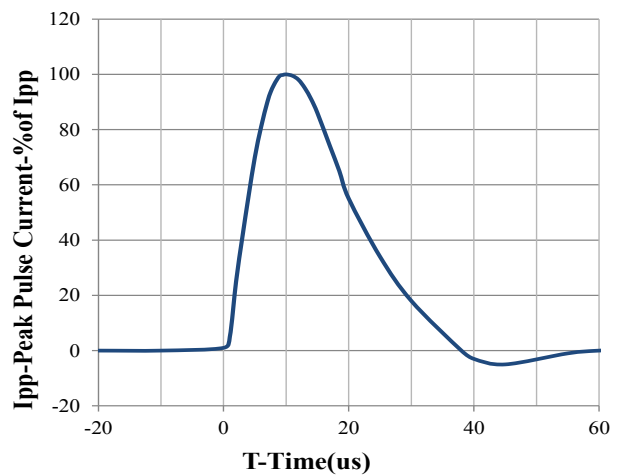

8 X 20us Pulse Waveform

SOD-323 Package Outline Drawing

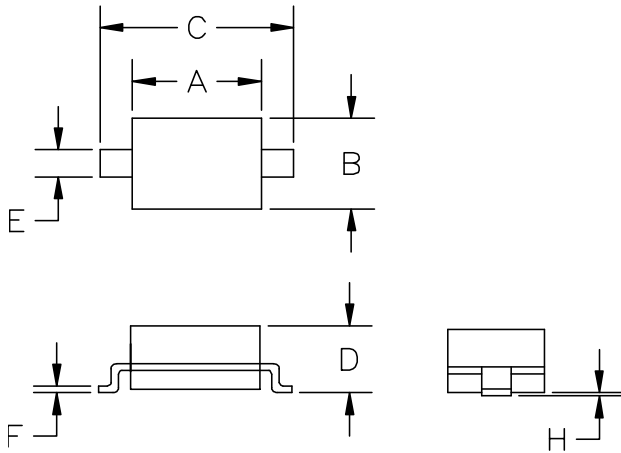

SYM	DIMENSIONS			
	MILLIMETERS		INCHES	
	MIN	MAX	MIN	MAX
A	1.50	1.80	0.060	0.071
B	1.20	1.40	0.045	0.054
C	2.30	2.70	0.090	0.107
D	-	1.10	-	0.043
E	0.30	0.40	0.012	0.016
F	0.10	0.25	0.004	0.010
H	-	0.10	-	0.004

Suggested Land Pattern

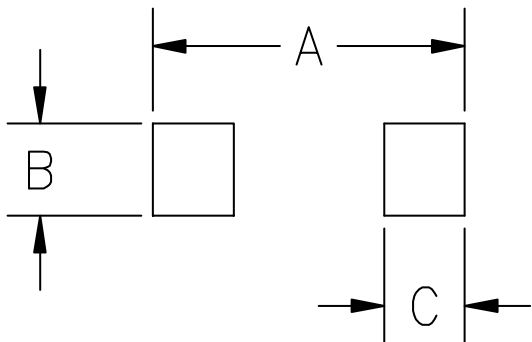

SYM	DIMENSIONS	
	MILLIMETERS	INCHES
A	3.15	0.120
B	0.80	0.031
C	0.80	0.031

Contact Information

Changzhou D-first Electronics CO.,Ltd.

www.first-electronic.com

Email: xhf@first-electronic.cn

Phone: +86 (0519) 88171671